

ERASER™

Conveyor Belt Cleaning System



ARGONICS

⚠ WARNING

Always obey all applicable safety rules.

Be sure all power to the conveyor has been disconnected and controls are locked out.

Installation Tools Required

- Tape measure
- Cutting Torch or Hole Saw (3½")
- Level
- Scribe or Chalk
- Welder or Drill
- ½" End Wrench
- ¾" End Wrench
- 1" End Wrench or Crescent Wrench

Bolts, lock washers and nuts for mounting are not supplied

Safe Torque Ratchet System - Assembly Breakdown

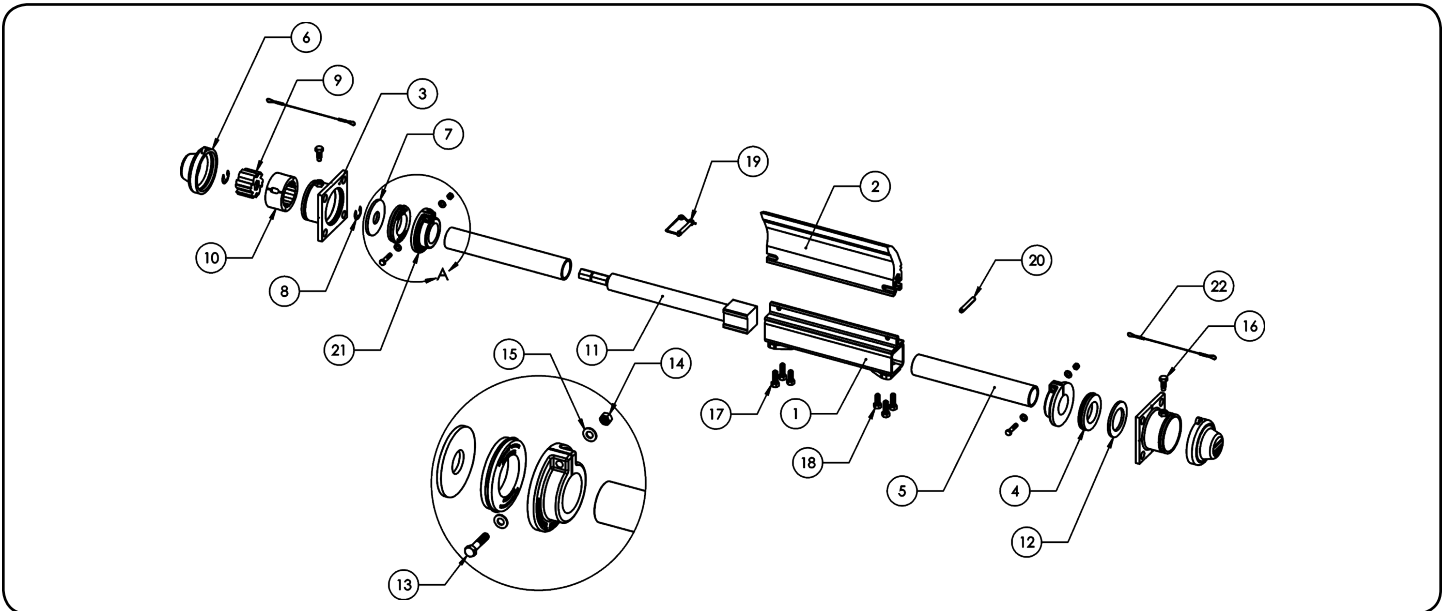

Number	Part Number	Quantity	Description
1	CP-AR-"XX" A	1	Mainframe
2	CP-RE-"XX"-G83	1	Raptor Blade
3	CP-AR-30R	2	Standard Ratchet Mounting Spool
4	CP-AR-23-RT-B93	2	Standard Inner Snap Seal
5	CP-AR-12B or CP-AR-22B	2	Stub End Extended Stub End
6	CP-AR-52B-Y83	2	Standard Dust Cap
7*	CP-AR-41F	1	Standard Ratchet Spool Washer
8*	CP-AR-98407A156	2	Retaining Ring
9*	CP-AR-22C-G83	1	Standard Inner Ratchet Catch
10*	CP-AR-32C-G83	1	Standard Outer Ratchet Catch
11*	CP-AR-1-1375-E-B93 or CP-AR-1-2075-E-B93	1	1" Perma-Torque Tensioner 1" Extended Perma-Torque Tensioner
12	CP-AR-41F-ST	1	Std. Rat. Spool Washer - Single Tensioner
13	BOLT-0.38X1.75NC-ZC	2	Bolt, .375"-16 NC, Zinc-Plated 1.75" Long
14	NUT-016	2	Nut, .375"-16NC, Zinc-Plated
15	WASH-0.38-F-SAE-ZINC	4	Washer, SAE .375", Zinc-Plated
16	CP-AR-512540	2	Bolt, .5"-13 NC, Zinc-Plated 1.25" Long
17	CP-AR-5150S	4	Stainless Hex Head Set Screw 1/2" x 1-1/2"
18	CP-AR-5125S	2	Stainless Hex Head Set Screw 1/2" x 1-1/4"
19	CP-AR-250	1	Safety Snap Pin 3/8" x 2-1/4"
20	CP-AR-305	1	Spring Pin
21	CP-AR-LC5-G83	2	Standard Locking Collar
22	CP-AR-120105	2	Wire Rope Lanyard; 12" Long, 3/64" Wire

* Systems 46" and above come standard with dual tensioners and require double of each of the noted parts.

INSTALLATION

Note:

This Eraser primary belt cleaning system is designed to be used on conveyor pulleys of 14" in diameter and larger. For a pulley smaller than 14" in diameter, we recommend our Micro Eraser for proper cleaning of your conveyor system.

Step One: Calculations

Measure the distance from the center of your pulley shaft to the outside surface of your conveyor belt. This will be your outside radius ("A" on figure 1). Double it to find your outside diameter. Find your outside pulley diameter on the dimension table to the right. Add the corresponding "X" dimension to your outside diameter. (Example: 28" Radius + 4" = 32"). This is your "Y" dimension (Y = 18"). The illustrated "Z" dimension is a minimum value and provides for the optimum mounting position.

Dimension Table - Table 1		
Outside Diameter*	X	Z
14" - 28"	4"	9 3/4"
29" & Larger	3"	9 3/4"

*Includes lagging and belt thickness.

Step Two: Layout

From the center of the pulley shaft, scribe an arc (equal to your "Y" dimension) on the outside of the mounting structure wall. Then measure down from the center of the pulley shaft using the "Z" dimension, and using a level, scribe a horizontal line across the mounting structure that intersects the arc at "Y". Now draw a vertical line approximately 8" long which bisects the horizontal line at the intersection. This bisected point will be the center point of the mounting spool location. If no structure is available at this point, a mounting structure will need to be added.

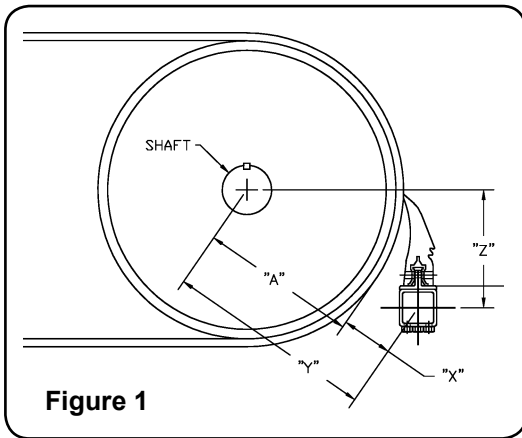

Figure 1

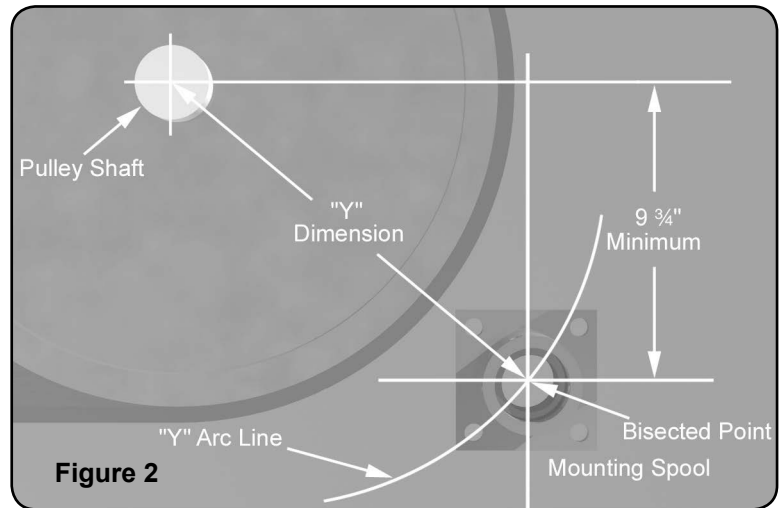
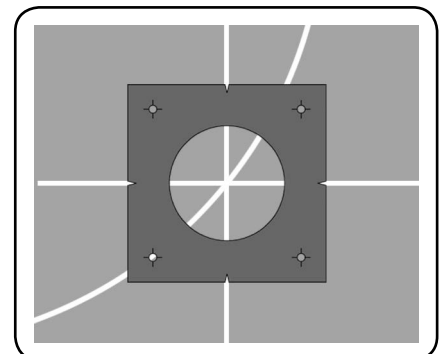

Figure 2

After you have determined the mounting location for your belt cleaning system, align the supplied template (found on page 11 of this guide) with your bisected horizontal and vertical lines on the mounting structure wall and transfer the center hole, bolt holes and perimeter of the template to the chute wall using your scribe.



INSTALLATION - Single Tensioner

Step Three (A): Mounting systems equipped with a single tensioner

Cut the tensioner hole which was scribed on the mounting structure (your finished hole should be approx. 3½" in diameter).

NOTES:

- For Bolt In Only - Using the bolt circles that you scribed as a guide, drill four 1⅜" diameter holes to accept ¾" diameter grade 8 bolts.

Single tensioner Eraser systems are shipped with the tensioner on the left side, facing the head pulley. If you need to mount your tensioner on the right side please refer to tensioner assembly instructions on page 9.



Remove the urethane locking collars from the stub ends.

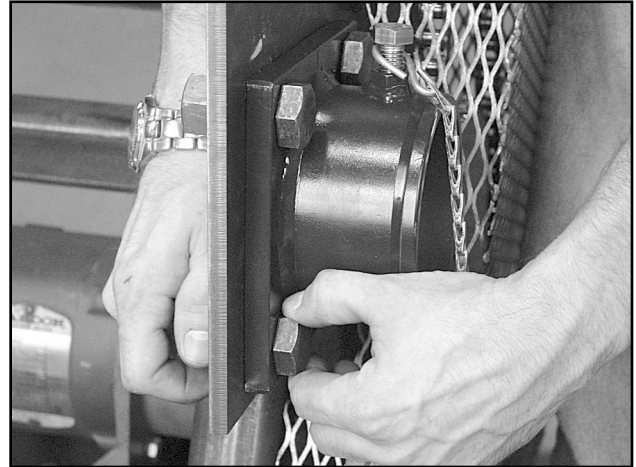

Remove the mounting spool from the non-tensioner side of the system. Line up the spool with the holes in the chute wall, then bolt it into place using four ¾" grade 8 bolts and lock washers. You can also choose to stitch weld on the flat sides of the mounting spool.



Using a ½" end wrench, loosen the three setscrews located on the bottom of each end of the mainframe. Remove the entire tension cartridge from the left side of the mainframe.



Lift the mainframe into position. Insert the stub end into the mounting spool on the non-tensioner side.

INSTALLATION - Single Tensioner

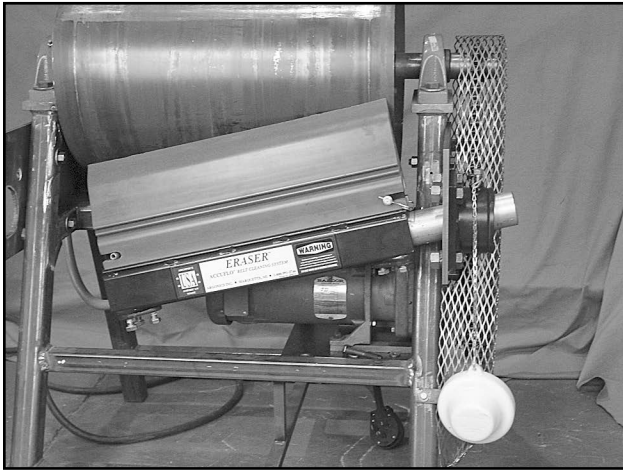

Temporarily retighten the three setscrews to hold the mainframe in place. Then carefully lower to let system hang in place.

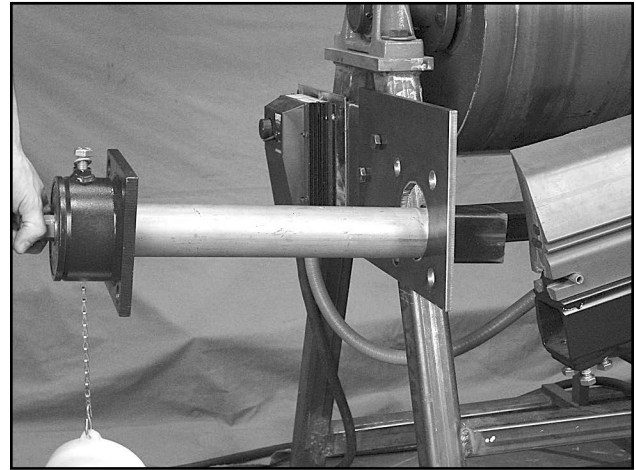

On the other side of the chute, slide the tensioner cartridge through the chute wall and insert it into the mainframe.

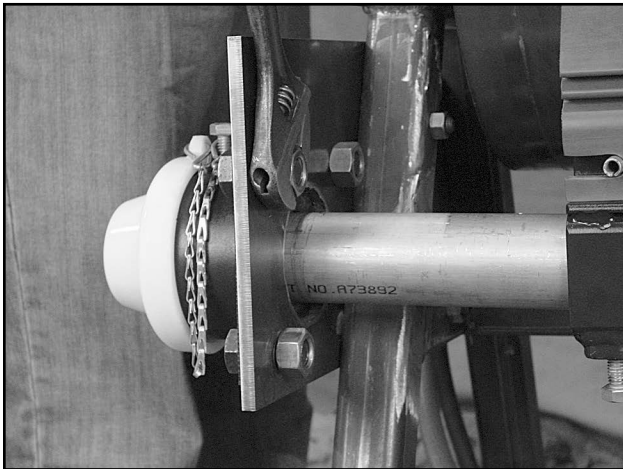

Temporarily retighten the setscrew on tensioner side to stabilize system. Bolt or stitch weld the mounting spool on the tensioner cartridge to the chute wall.

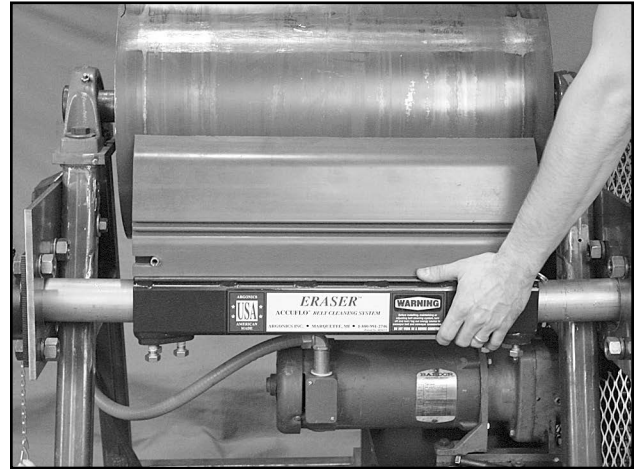

Loosen the setscrews and center the mainframe and blade to the belt. Tighten the setscrews to secure the stub ends.

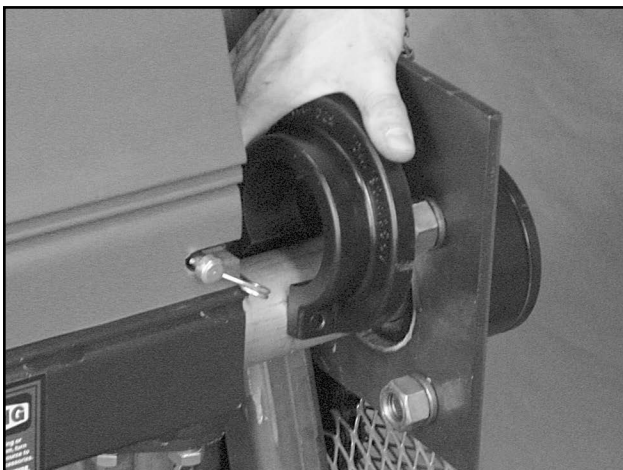

Install the urethane locking collars by sliding them over the stub end, snugging them to the chute wall. Tighten the bolts to secure.

IMPORTANT

At the top point of the mounting spool, the inner ratchet catch must always point away from the load pulley.

**PROCEED TO
TENSIONING INSTRUCTIONS
ON PAGE 8**

INSTALLATION - Dual Tensioner

Step Three (B): Mounting systems equipped with a dual tensioner

Cut the tensioner holes which were scribed on the mounting structure (your finished holes should be approx. 3½" in diameter).

NOTES:

- For Bolt In Only - Using the bolt circles that you scribed as a guide, drill four 13/16" diameter holes to accept 3/4" diameter grade 8 bolts per mounting spool.



Remove the urethane locking collars from the stub ends.

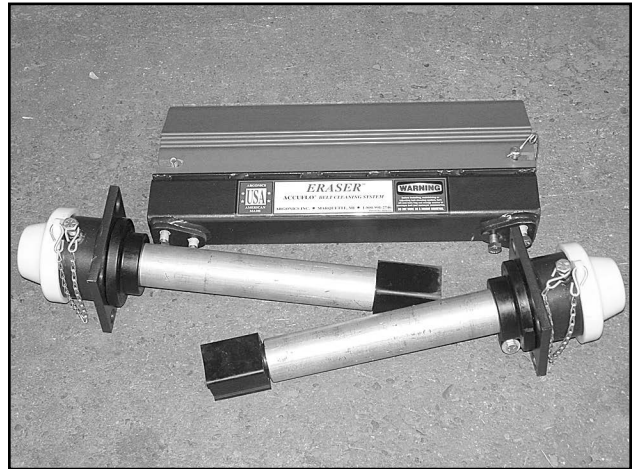

Remove both tension cartridges from the mainframe.

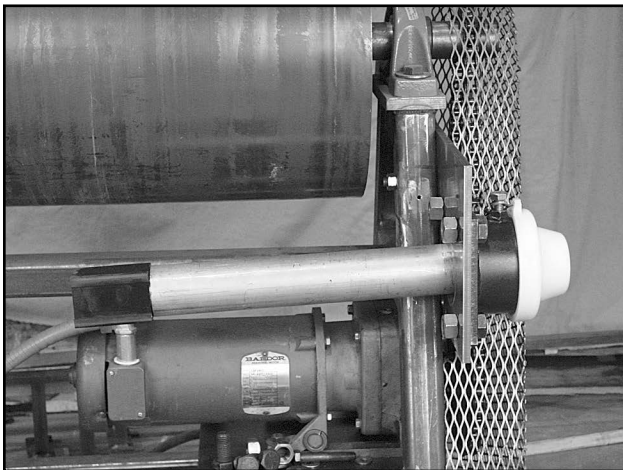

If there is room, slide the first tensioner cartridge through the chute wall and line up the mounting spool with the template that was transferred to the chute wall. Now bolt or weld into place.

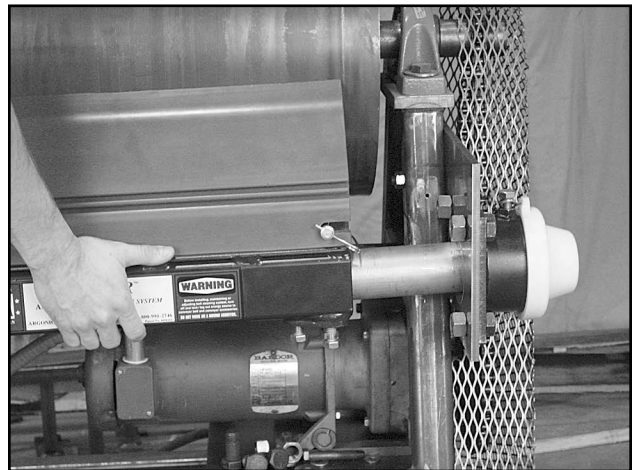

Lift the mainframe into position. Slide the mainframe onto the cartridge, then temporarily retighten the three setscrews on the tensioner side to stabilize system.

INSTALLATION - Dual Tensioner

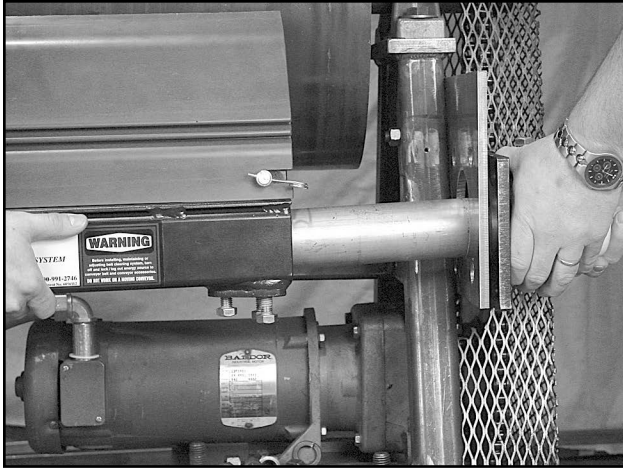

If there is not a lot of room between the chute walls, hold the mainframe in place and slide the tensioner cartridge into the mainframe. Bolt or weld the mounting spool into position and tighten the setscrews.

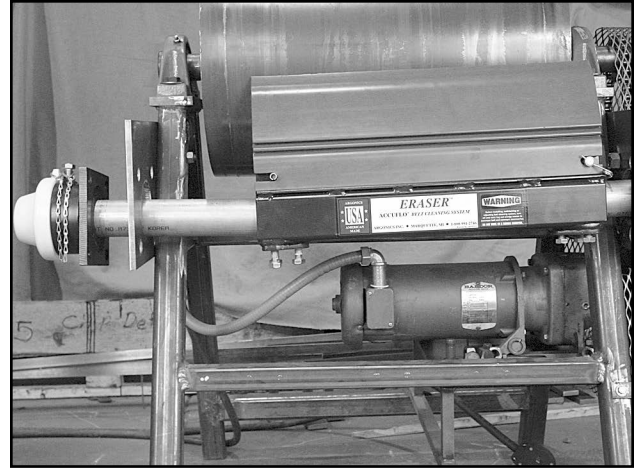

Slide the second tensioner cartridge through the chute wall and insert into mainframe. Temporarily retighten the setscrew on tensioner side to stabilize system. Bolt or stitch weld the mounting spool on the tensioner cartridge to the chute wall.

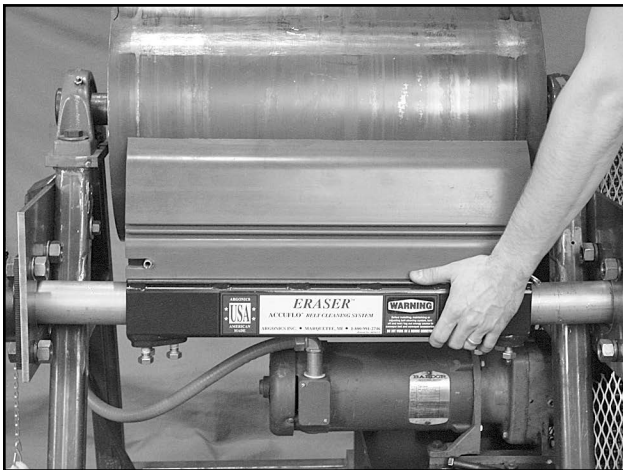

Loosen the setscrews and center the mainframe and blade to the belt. Tighten the setscrews to secure the stub ends.

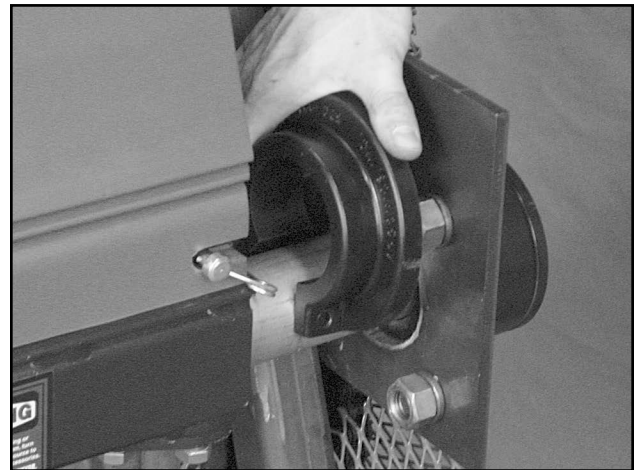

Install the urethane locking collars by sliding them over the stub end, snugging them to the chute wall. Tighten the bolts to secure.

IMPORTANT

At the top point of the mounting spool, the inner ratchet catch must always point away from the load pulley.

PROCEED TO TENSIONING INSTRUCTIONS ON PAGE 8

INSTALLATION - Tensioning

Step Four: Tensioning

The Eraser system is equipped with our patented internal Perma-Torque tensioner and our Safe Torque ratchet system. The Perma-Torque is an adjustable elastomeric tensioner. The tensioner may be adjusted from a recommended minimum of 20 foot-pounds of force to a maximum of 80 foot-pounds. Exceeding tensioning of 24 clicks or 480° of rotation could damage the tensioner as well as the Safe Torque ratchet system. Four (4) clicks, or 90° of rotation is recommended for most applications.

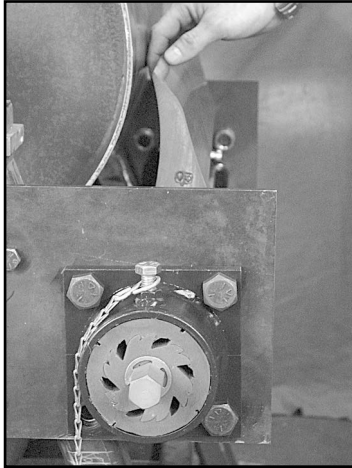

To tension, first position the alignment notch on the outer ratchet catch with the mounting spool set screw. Grab the blade and rotate to align the ratchet notch.



When notch is aligned, tighten the setscrew. (Arrow indicates proper notch position)

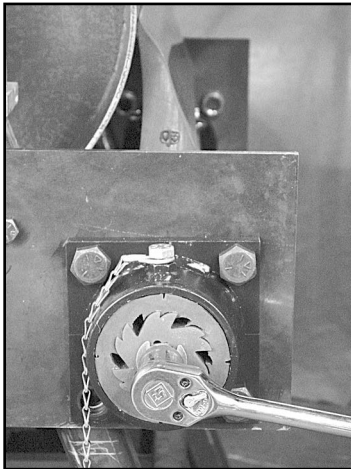

Use a 1" socket wrench on the exposed tensioner hex rod and turn the tensioner up and towards the pulley until the blade makes contact with the belt. Start tensioning by counting the clicks until you have reached the desired rotation. Four (4) clicks or 90° of rotation is the factory recommended setting. Repeat the same number of clicks on the opposite side for a dual tensioner system. Re-attach the dust cap(s).

Tensioning Guide		
# of clicks	Degrees	ft-lbs
4	90°*	15
6	120°	20
9	180°	30
12	240°	40
15	300°	50
18	360°	60
21	420°	70
24	480°	80

Do Not Overtension
*90° is our standard which is recommended for most applications.

Releasing Tension

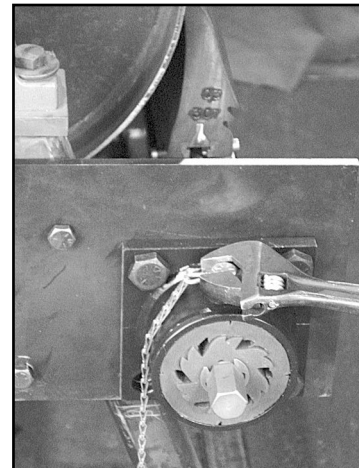

When you need to release tension, just loosen the mounting spool set screw. You will see the outer ratchet rotate as the tension is released.

INSTALLATION - Left to Right Tensioner Conversion

Tensioner Conversion Instructions

To mount a single tensioned Eraser system with the tensioner on the right side instead of the left side, you will need to switch the entire tensioning spool to the other side of the mainframe, as well as the direction that the ratchet gears are oriented. It is recommended that you perform this conversion on the ground before the system is mounted.



Remove the retainer clip from the hex rod using a flat blade screwdriver. Be sure not to lose the retainer clip.

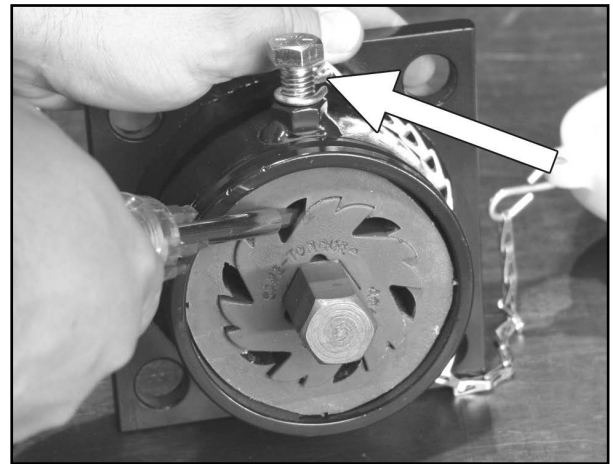

Unscrew the setscrew at the top of the mounting spool and remove both the inner ratchet and outer catch. Make sure you note what direction the gears are pointing.



Flip both the inner ratchet and outer catch so the gear teeth are pointed in the opposite direction and slide both back onto the hex rod.

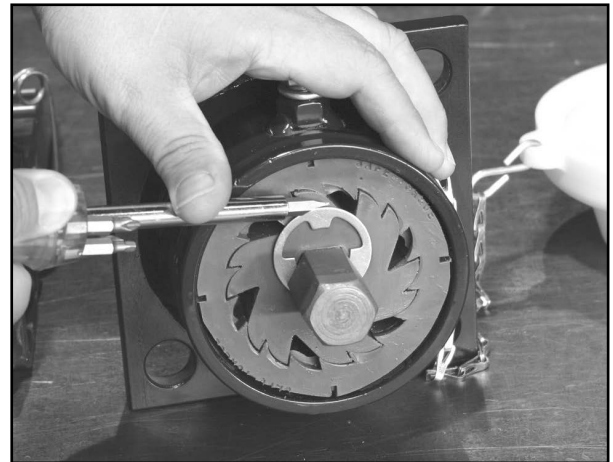

Align the outer catch notch to the top of the mounting spool, tighten the set screw and then re-insert the retaining clip to the outer groove of the hex rod.

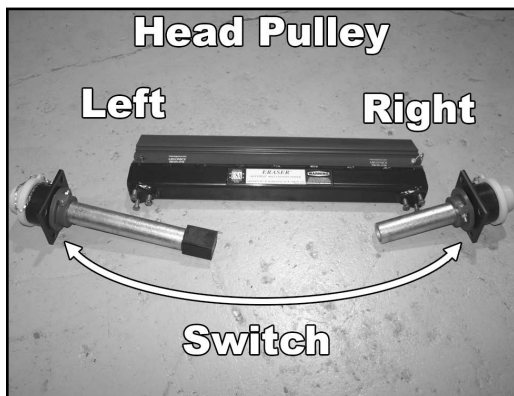

Your Eraser system comes with the tensioner mounted on the left. You will need to switch the entire mounting spool assembly to the right side of the mainframe.

IMPORTANT

At the top point of the mounting spool, the inner ratchet catch must always point away from your conveyor load pulley.

Continue following the installation instructions located on page 4.

NOTES

Notes:



MOUNTING TEMPLATE

Transfer the drawing below to cardboard, and use as your mounting spool template.

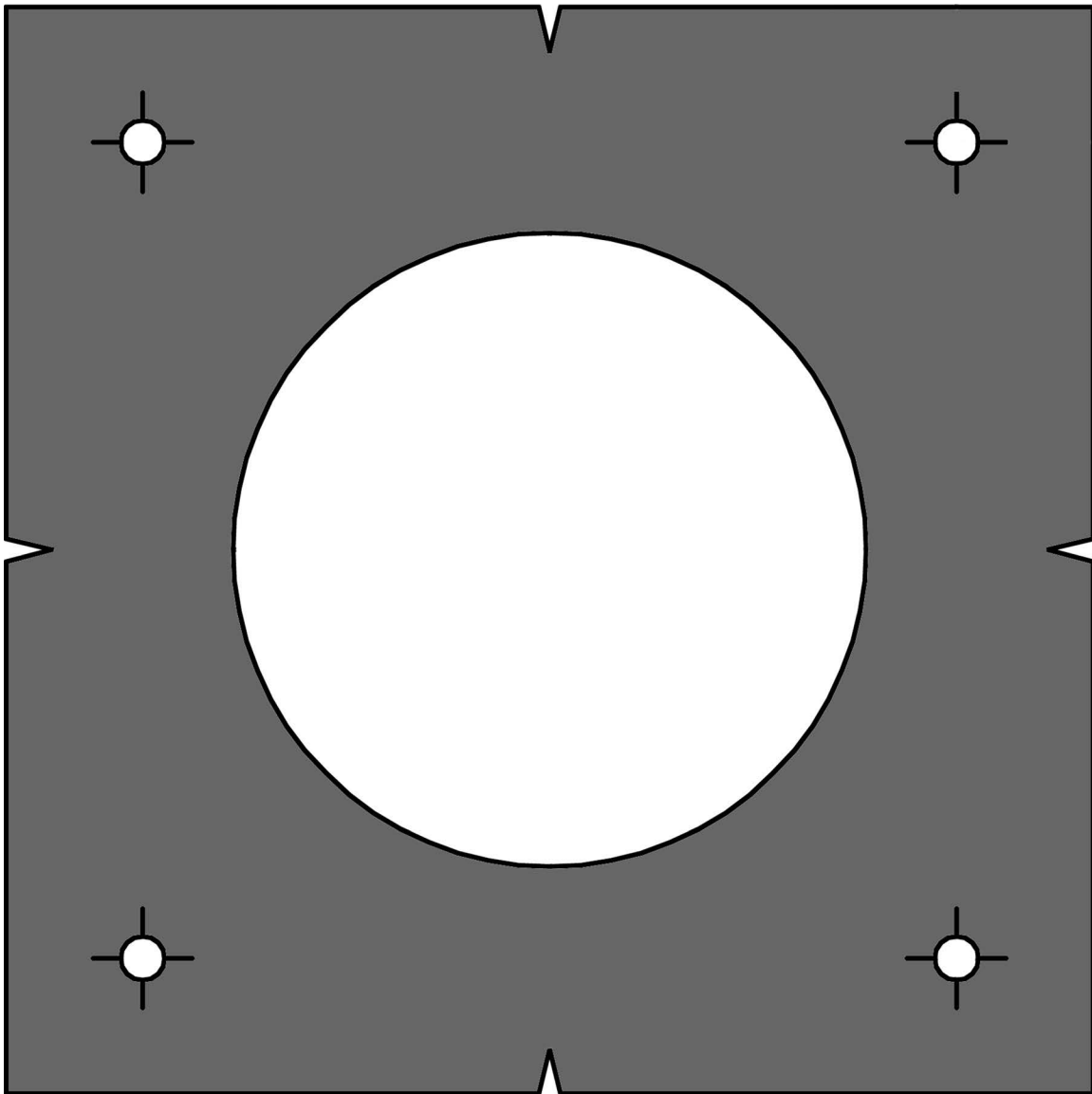

Template is drawn to actual size.

Other Quality Products From Argonics

*Largest Selection of
Conveyor Belt Cleaner
Replacement Blades*

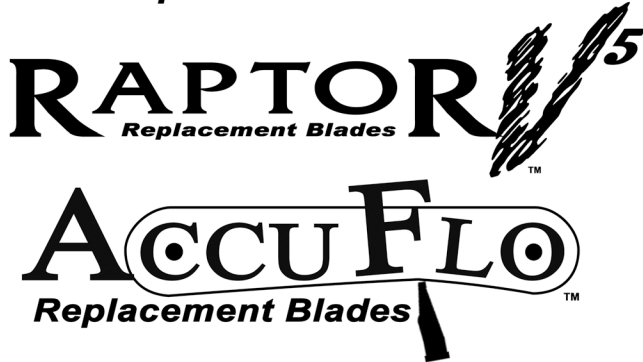

*The World's Best Conveyor
Belt Cleaning Systems*

EraserTM
Conveyor Cleaners

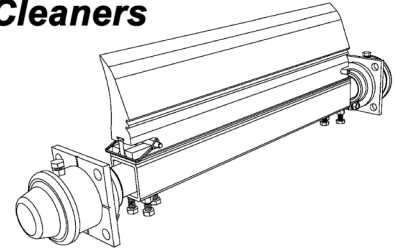

*The Most Complete Line
of Conveyor Support Systems*



Impact - Slide - Roll & Slide

Also Available From:



Classifier Shoes
Screen Deck Accessories
Belt Skirting
Snap-Loc Dust Seal
Modular Wear Liners
Wear Resistant Sheets
Concrete Mixer Lining Systems